

P1: M-042

P2: M-048A

Customer No.: No.:1

P1

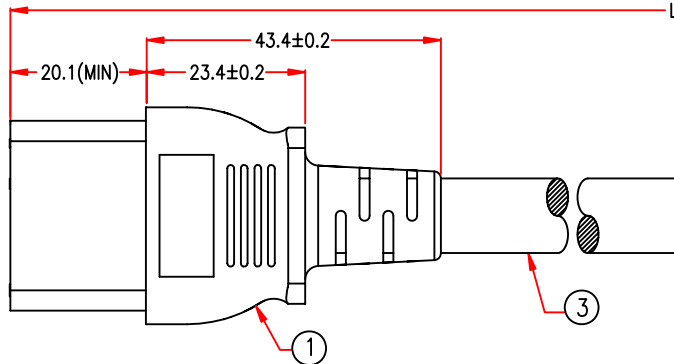
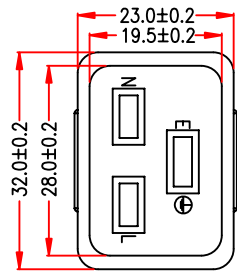

IEC 60320 C19

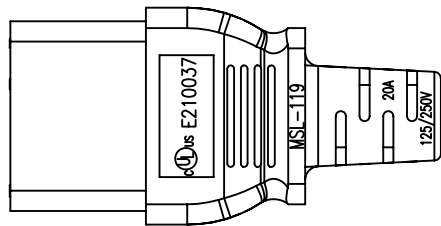

②

NEMA L6-20

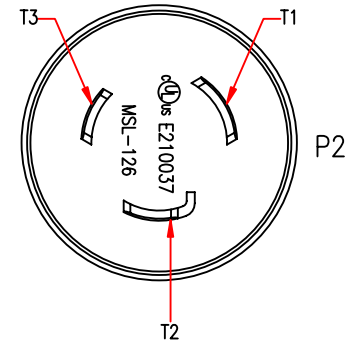

P2

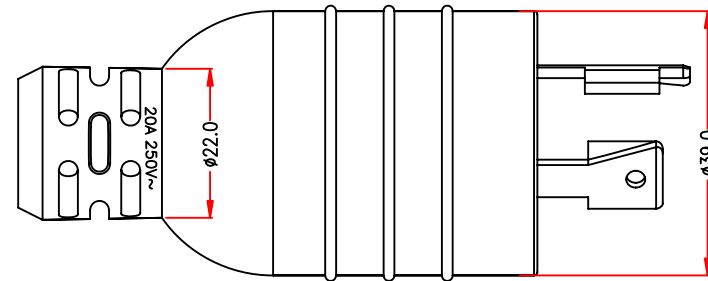

PACKING A: ≥1FT

PACKING B: ≥2FT

PACKING C: <2FT

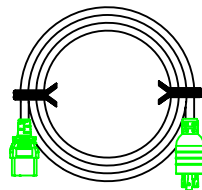
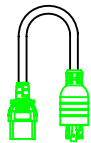
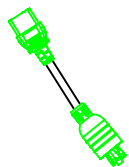

MARKING: (UL) SJT 3/C 12AWG(3.31MM²) VW-1 105°C 300V E204978

CSA SJT 3/C 3.31MM²(12AWG) FT2 105°C 300V 204790 MSL

	P1	P2
BLACK	L	T1
WHITE	N	T3
GREEN	E	T2

P1. P2: E210037

NOTE: All relevant materials are complied with RoHS directive .

No.	DESCRIPTION	Q'TY	Supplier
3	UL SJT 12AWG x 3C, OD 11.0mm, JACKET BLACK, DRAWING No. EPSVT011203C-123	H5TC16-0304K09	L-20mm M304
	MOLDED PVC 35P, COLOR BLACK	H1BC02-0304	M304
	BRACKET: XXXX		1Set M767
	TERMINAL: 97656BL-0 (T3)		1 M257
2	TERMINAL: 97655BL-0 (T2)		1 M257
	TERMINAL: 97654BL-0 (T1)		1 M257
	MOLDED PVC 35P, COLOR BLACK	H1BC02-0304	1 M304
1	BRACKET: YST-037	A1QC36-0767	1Set M767
	TERMINAL: 98739ABS-0	A1QB33-0257	3 M257

APPROVED	HOSKINS	TOTAL CABLE SOLUTIONS		Unless Otherwise SPEC. Tolerances:	
CHECKED		12/OCT/15	DRAWN NAME	POWER SUPPLY CORDS & CORDS SETS	
DRAWING	HOSKINS	12/OCT/15	PRODUCT NO.	PWR-9QJL-02xx-xxxx	UNIT: mm

0.	±0.5
.0	±0.3
.00	±0.1

NOTE: Cable Length Unless Otherwise Spec. Tolerances: Under 6FT ±25mm; Another ±50mm